

# JVC



**CD RECEIVER**

**KD-S7350/KD-S690**

ENGLISH

**RECEPTOR CON CD**

**KD-S7350/KD-S690**

ESPAÑOL

**RECEPTEUR CD**

**KD-S7350/KD-S690**

FRANÇAIS

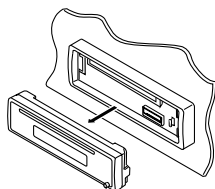

**KD-S7350**

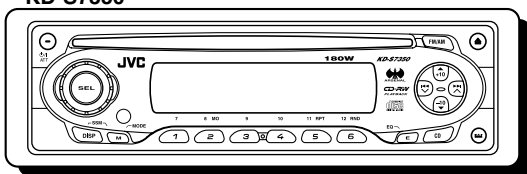

**KD-S690**

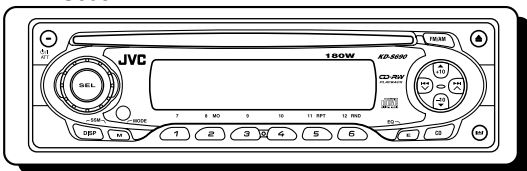

**COMPACT  
disc  
DIGITAL AUDIO**

**CD-RW  
PLAYBACK**

For installation and connections, refer to the separate manual.

Para la instalación y las conexiones, refiérase al manual separado.

Pour l'installation et les raccordements, se référer au manuel séparé.

**For customer Use:**

Enter below the Model No. and Serial No. which are located on the top or bottom of the cabinet. Retain this information for future reference.

Model No. \_\_\_\_\_

Serial No. \_\_\_\_\_

## **INSTRUCTIONS**

**MANUAL DE INSTRUCCIONES**  
**MANUEL D'INSTRUCTIONS**

GET0131-001A

[J]

**INFORMATION (For U.S.A.)**

This equipment has been tested and found to comply with the limits for a Class B digital device, pursuant to Part 15 of the FCC Rules. These limits are designed to provide reasonable protection against harmful interference in a residential installation. This equipment generates, uses, and can radiate radio frequency energy and, if not installed and used in accordance with the instructions, may cause harmful interference to radio communications. However, there is no guarantee that interference will not occur in a particular installation. If this equipment does cause harmful interference to radio or television reception, which can be determined by turning the equipment off and on, the user is encouraged to try to correct the interference by one or more of the following measures:

- Reorient or relocate the receiving antenna.
- Increase the separation between the equipment and receiver.
- Connect the equipment into an outlet on a circuit different from that to which the receiver is connected.
- Consult the dealer or an experienced radio/TV technician for help.

**IMPORTANT FOR LASER PRODUCTS****Precautions:**

1. CLASS 1 LASER PRODUCT
2. **CAUTION:** Invisible laser radiation when open and interlock failed or defeated. Avoid direct exposure to beam.
3. **CAUTION:** Do not open the top cover. There are no user-serviceable parts inside. Leave all servicing to qualified service personnel.
4. **CAUTION:** This CD player uses invisible laser radiation, however, is equipped with safety switches to prevent radiation emission when unloading CDs. It is dangerous to defeat the safety switches.
5. **CAUTION:** Use of controls, adjustments or performance of procedures other than those specified herein may result in hazardous radiation exposure.

**How to reset your unit**

While holding SEL (select), press  $\text{O}/\text{I}/\text{ATT}$  (standby/on/attenuator) for more than 2 seconds. This will reset the built-in microcomputer.

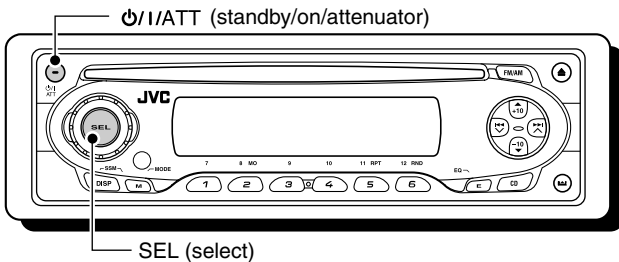
**Notes:**

- Your preset adjustments—such as preset channels or sound adjustments—will also be erased.
- If a CD is in the unit, it will eject when you reset the unit. Be careful not to drop the CD.

Thank you for purchasing a JVC product. Please read all instructions carefully before operation, to ensure your complete understanding and to obtain the best possible performance from the unit.

# CONTENTS

How to reset your unit .....	2	<b>SOUND ADJUSTMENTS .....</b>	<b>15</b>
How to use the M (MODE) button .....	3	Selecting preset sound modes	
<b>LOCATION OF THE BUTTONS .....</b>	<b>4</b>	(C-EQ: custom equalizer) .....	15
Control panel .....	4	Adjusting the sound .....	16
Remote controller .....	5	<b>OTHER MAIN FUNCTIONS .....</b>	<b>17</b>
Preparing the remote controller .....	6	Selecting the level display .....	17
<b>BASIC OPERATIONS .....</b>	<b>7</b>	Detaching the control panel .....	18
Turning on the power .....	7	<b>TROUBLESHOOTING .....</b>	<b>19</b>
Setting the clock .....	8	<b>MAINTENANCE .....</b>	<b>20</b>
<b>RADIO OPERATIONS .....</b>	<b>9</b>	Handling discs .....	20
Listening to the radio .....	9	<b>SPECIFICATIONS .....</b>	<b>21</b>
Storing stations in memory .....	10		
Tuning in to a preset station .....	11		
<b>CD OPERATIONS .....</b>	<b>12</b>		
Playing a CD .....	12		
Locating a track or a particular portion			
on a CD .....	13		
Selecting CD playback modes .....	14		
Prohibiting CD ejection .....	14		

## How to use the M (MODE) button

If you press M (MODE), the unit goes into functions mode and the number buttons and ▲/▼ buttons work as different function buttons.

Ex.: When number button 2 works as MO (monaural) button.

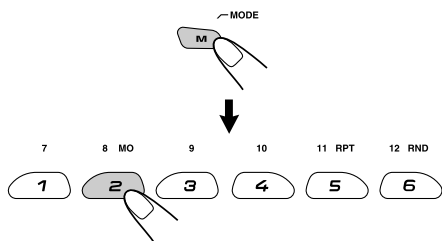

**To use these buttons for original functions again after pressing M (MODE), wait for 5 seconds without pressing any of these buttons until the functions mode is cleared.**

- Pressing M (MODE) again also clears the functions mode.

### BEFORE USE

#### \* For safety....

- Do not raise the volume level too much, as this will block outside sounds, making driving dangerous.
- Stop the car before performing any complicated operations.

#### \* Temperature inside the car....

If you have parked the car for a long time in hot or cold weather, wait until the temperature in the car becomes normal before operating the unit.



# LOCATION OF THE BUTTONS

ENGLISH

## Control panel

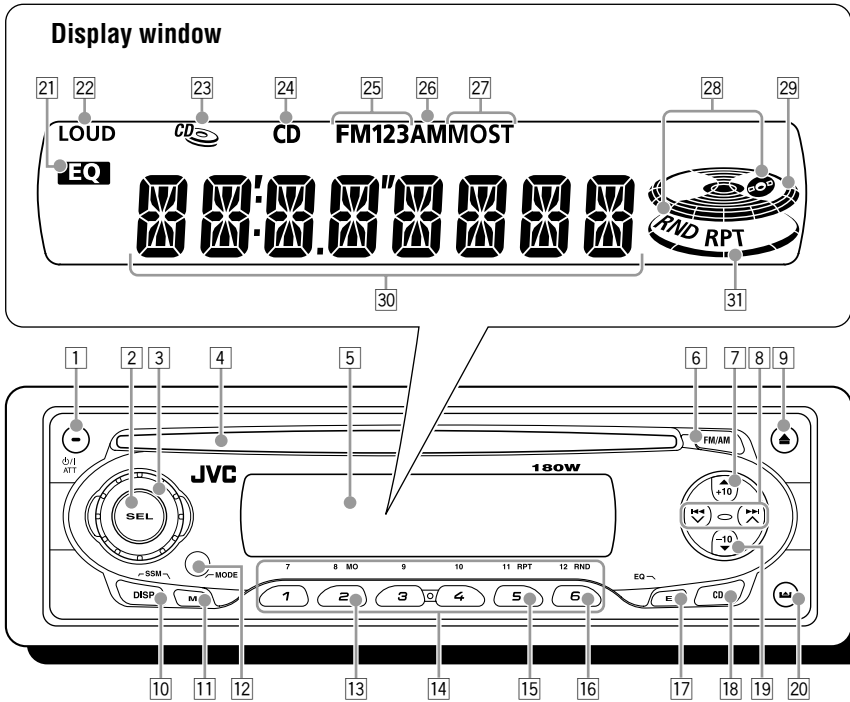

1 (standby/on/attenuator) button

2 (select) button

3 Control dial

4 Loading slot

5 Display window

6 FM/AM button

7 ▲ (up) button  
+10 button

8 ▼ / ► buttons

9 ▲ (eject) button

10 DISP (display) button

• Also functions as SSM buttons when pressed together with M (MODE) button.

11 M (MODE) button

• Also functions as SSM buttons when pressed together with DISP (display) button.

12 Remote sensor

13 MO (monaural) button

14 Number buttons

15 RPT (repeat) button

16 RND (random) button

17 E (EQ: equalizer) button

18 CD button

19 ▼ (down) button  
-10 button

20 (control panel release) button

### Display window

21 EQ (equalizer) indicator

22 LOUD (loudness) indicator

23 CD-in indicator

24 CD indicator

25 FM band indicators (FM1, FM2, FM3)

26 AM band indicator

27 Tuner reception indicators

MO (monaural), ST (stereo)

28 RND (disc random) indicator

29 Volume (or audio) level indicator

30 Main display

31 RPT (repeat) indicator



# Remote controller

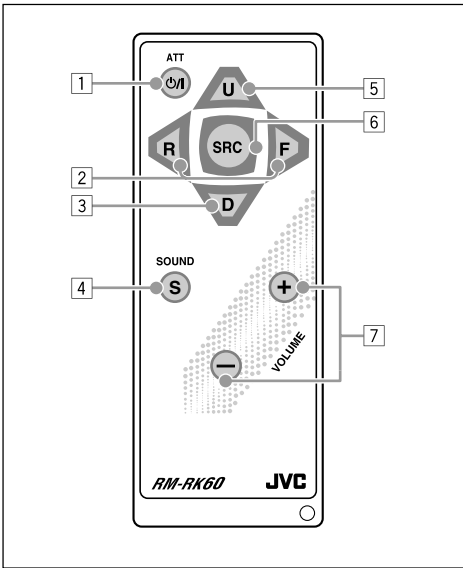

3 Selects the preset stations while listening to the radio.  
Each time you press the button, the preset station number increases, and the selected station is tuned in.

4 Selects the sound mode (C-EQ: custom equalizer).  
Each time you press the button, the sound mode (C-EQ) changes.

5 Selects the band while listening to the radio.  
Each time you press the button, the band changes.

6 Selects the source.  
Each time you press the button, the source changes.

7 Functions the same as the control dial on the main unit.

**Note:** These buttons do not used for adjusting "CLOCK H," "CLOCK M," and "LEVEL" (see pages 8 and 17).

- 1 • Turns on the unit if pressed when the unit is turned off.
  - Turns off the unit if pressed and held until "SEE YOU" appears on the display.
  - Drops the volume level in a moment if pressed briefly.  
Press again to resume the volume.
- 2 • Searches for stations while listening to the radio.
  - Fast-forwards or reverses the track if pressed and held while listening to a CD.
  - Skips to the beginning of the next track or goes back to the beginning of the current (or previous) tracks if pressed briefly while listening to a CD.

## Preparing the remote controller

Before using the remote controller:

- Aim the remote controller directly at the remote sensor on the main unit. Make sure there is no obstacle in between.

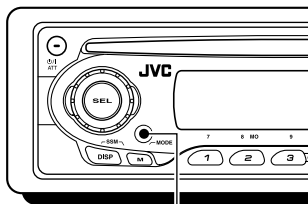

Remote sensor

- Do not expose the remote sensor to strong light (direct sunlight or artificial lighting).

### Installing the battery

When the controllable range or effectiveness of the remote controller decreases, replace the battery.

#### 1. Remove the battery holder.

- 1) Push out the battery holder in the direction indicated by the arrow using a ball point pen or a similar tool.
- 2) Remove the battery holder.

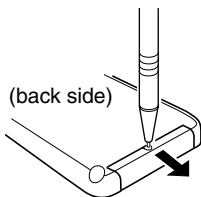

#### 2. Place the battery.

Slide the battery into the holder with the + side facing upwards so that the battery is fixed in the holder.

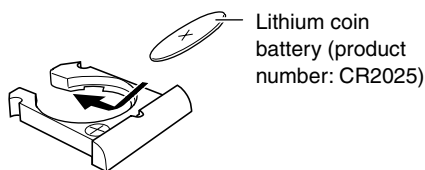

#### 3. Return the battery holder.

Insert again the battery holder by pushing it until you hear a clicking sound.

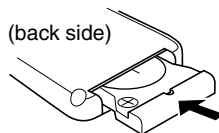

#### WARNING:

- Store the battery in a place which children cannot reach.  
*If a child accidentally swallows the battery, immediately consult a doctor.*
- Do not recharge, short, disassemble or heat the battery or dispose of in a fire.  
*Doing any of these things may cause the battery to give off heat, crack or start a fire.*
- Do not leave the battery with other metallic materials.  
*Doing this may cause the battery to give off heat, crack or start a fire.*
- When throwing away or saving the battery, wrap in tape and insulate; otherwise, it may cause the battery to give off heat, crack or start a fire.
- Do not poke the battery with tweezers or similar tools.  
*Doing this may cause the battery to give off heat, crack or start a fire.*

#### CAUTION:

*DO NOT* leave the remote controller in a place (such as dashboards) exposed to direct sunlight for a long time. Otherwise, it may be damaged.

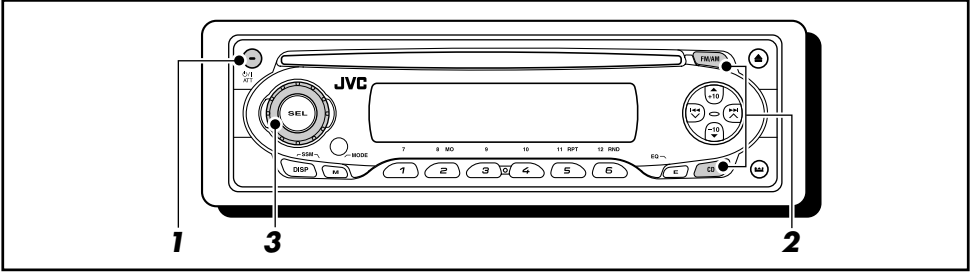

## Turning on the power

### 1 Turn on the power.



**Note on One-Touch Operation:**

When you select a source in step 2 below, the power automatically comes on. You do not have to press this button to turn on the power.

### 2 Select the source.

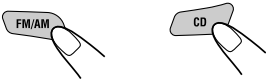

To operate the tuner (FM or AM), see pages 9 – 11.

To play a CD, see pages 12 – 14.

### 3 Adjust the volume.

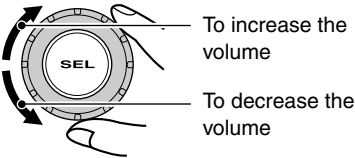

Volume (or audio) level indicator (see page 17)

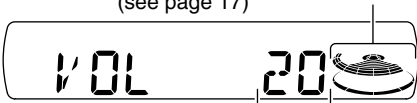

Volume level appears.

### 4 Adjust the sound as you want. (See pages 15 and 16.)

#### To drop the volume in a moment

Press  $\phi$ /I/ATT briefly while listening to any source. “ATT” starts flashing on the display, and the volume level will drop in a moment.

To resume the previous volume level, press the button briefly again.

- If you turn the control dial, you can also restore the sound.

#### To turn off the power

Press and hold  $\phi$ /I/ATT for more than one second.

“SEE YOU” appears, then the unit turns off.

- **If you turn off the power while listening to a CD,** CD play will start from where playback has been stopped previously, next time you turn on the power.

**CAUTION on Volume Setting:**

CDs produce very little noise compared with other sources. If the volume level is adjusted for the tuner, for example, the speakers may be damaged by the sudden increase in the output level. Therefore, lower the volume before playing a CD and adjust it as required during playback.

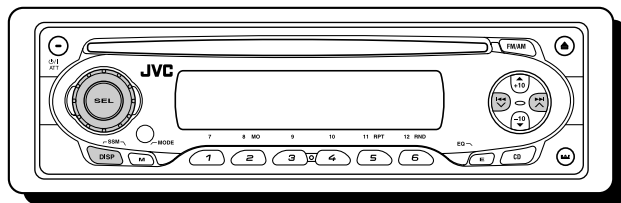

## Setting the clock

### 1 Press and hold SEL (select) for more than 2 seconds.

“CLOCK H,” “CLOCK M,” or “LEVEL” appears on the display.



### 2 Set the hour.

1 Select “CLOCK H” (hour) if not shown on the display.

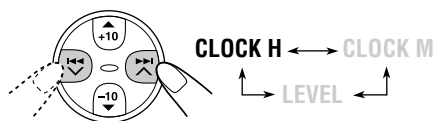

2 Adjust the hour.

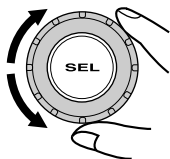

### 3 Set the minute.

1 Select “CLOCK M” (minute).

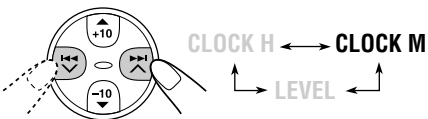

2 Adjust the minute.

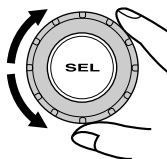

### 4 Finish the setting.



### To check the current clock time or change the display mode

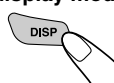

Press DISP (display) repeatedly. Each time you press the button, the display mode changes as follows:

- During tuner operation:

Frequency ↔ Clock

- During CD operation:

Elapsed playing time ↔ Clock

- During power off:

The power turns on and the clock time is shown for 5 seconds, then the power turns off.



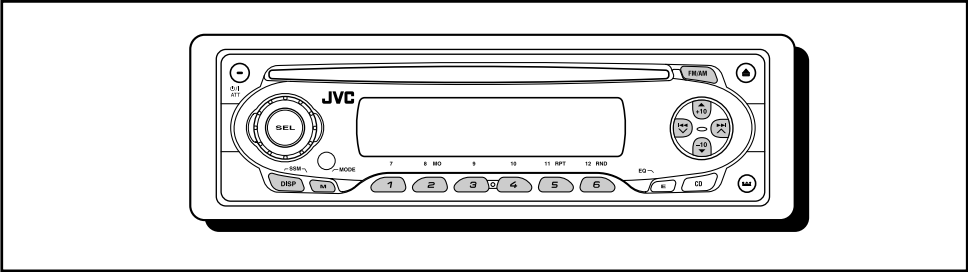

## Listening to the radio

You can use either automatic searching or manual searching to tune in to a particular station.

### Searching a station automatically: Auto search

#### 1 Select the band (FM1 – 3, AM).

Each time you press the button, the band changes as follows:

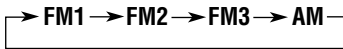

Selected band appears.

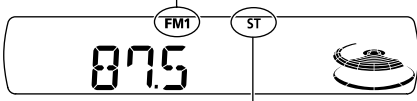

Lights up when receiving an FM stereo broadcast with sufficient signal strength.

**Note:**

This receiver has three FM bands (FM1, FM2, FM3). You can use any one of them to listen to an FM broadcast.

#### 2 Start searching a station.

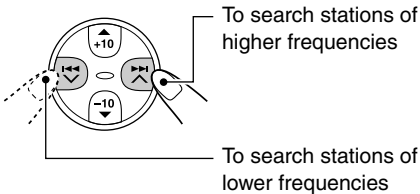

When a station is received, searching stops.

To stop searching before a station is received, press the same button you have pressed for searching.

### Searching a station manually: Manual search

#### 1 Select the band (FM1 – 3, AM).

Each time you press the button, the band changes as follows:

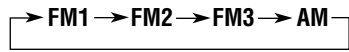

**Note:**

This receiver has three FM bands (FM1, FM2, FM3). You can use any one of them to listen to an FM broadcast.

#### 2 Press and hold **▶▶** **▲** or **◀◀** **▼** until “M” (manual) starts flashing on the display.

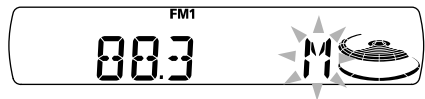
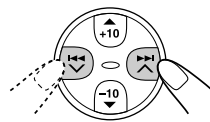



### 3 Tune in to a station you want while “M” (manual) is flashing.

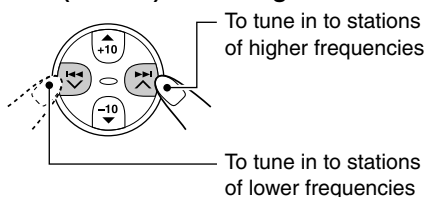

- If you release your finger from the button, the manual mode will automatically turn off after 5 seconds.
- If you hold down the button, the frequency keeps changing (in 200 kHz intervals for FM and 10 kHz for AM) until you release the button.

### When an FM stereo broadcast is hard to receive



1 Press M (MODE) to enter the functions mode while listening to an FM stereo broadcast.

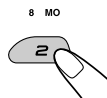

2 Press MO (monaural), while still in the functions mode, so that the MO indicator lights up on the display. Each time you press the button, the MO indicator lights up and goes off alternately.

MO (monaural) indicator



When the MO indicator is lit on the display, the sound you hear becomes monaural but the reception will be improved.

## Storing stations in memory

You can use one of the following two methods to store broadcasting stations in memory.

- Automatic preset of FM stations: SSM (Strong-station Sequential Memory)
- Manual preset of both FM and AM stations

### FM station automatic preset: SSM

You can preset 6 local FM stations in each FM band (FM1, FM2, and FM3).

#### 1 Select the FM band (FM1 – 3) you want to store FM stations into.



Each time you press the button, the band changes as follows:

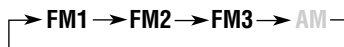

#### 2 Press and hold both buttons for more than 2 seconds.

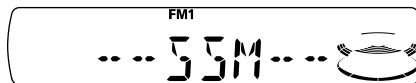
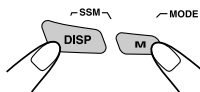

“-SSM-” appears, then disappears when automatic preset is over.

Local FM stations with the strongest signals are searched and stored automatically in the band number you have selected (FM1, FM2, or FM3). These stations are preset in the number buttons—No.1 (lowest frequency) to No.6 (highest frequency).

When automatic preset is over, the station stored in number button 1 will be automatically tuned in.

## Manual preset

You can preset up to 6 stations in each band (FM1, FM2, FM3, and AM) manually.

Ex.: Storing FM station of 88.3 MHz into the preset number 1 of the FM1 band.

### 1 Select the band (FM1 – 3, AM) you want to store stations into (in this example, FM1).



Each time you press the button, the band changes as follows:

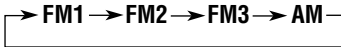

### 2 Tune in to a station (in this example, of 88.3 MHz).

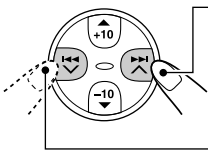

To tune in to stations of higher frequencies

To tune in to stations of lower frequencies

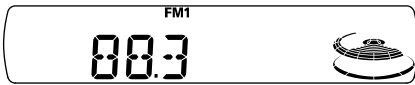

### 3 Press and hold the number button (in this example, 1) for more than 2 seconds.

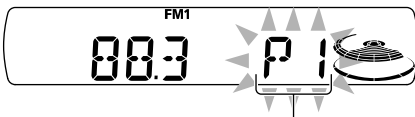
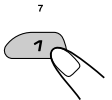

"P1" flashes for a few seconds.

### 4 Repeat the above procedure to store other stations into other preset numbers.

#### Notes:

- A previously preset station is erased when a new station is stored in the same preset number.
- Preset stations are erased when the power supply to the memory circuit is interrupted (for example, during battery replacement). If this occurs, preset the stations again.

## Tuning in to a preset station

You can easily tune in to a preset station. Remember that you must store stations first. If you have not stored them yet, see "Storing stations in memory" on pages 10 and 11.

### 1 Select the band (FM1 – 3, AM).



Each time you press the button, the band changes as follows:

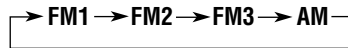

### 2 Select the number (1 – 6) for the preset station you want.

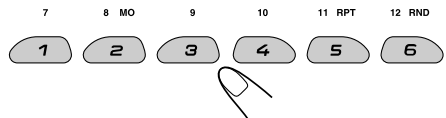

#### Note:

You can also use the ▲ (up) or ▼ (down) button on the unit to select the next or previous preset stations. Each time you press the ▲ (up) or ▼ (down) button, the next or previous preset station is tuned in.



# CD OPERATIONS

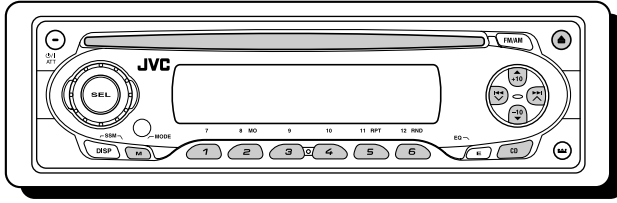

## Playing a CD

### Insert a CD into the loading slot.

The unit turns on, draws the CD and starts playback automatically.

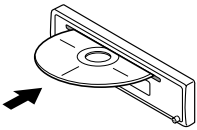

### Note on One-Touch Operation:

When a CD is already in the loading slot, pressing CD turns on the unit and starts playback automatically.

The CD-in indicator flashes.



The CD-in indicator light up.

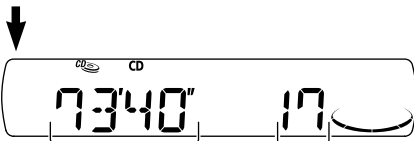

Total playing time of the inserted disc      Total track number of the inserted disc

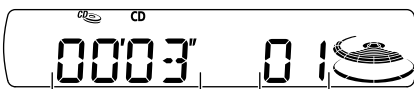

Elapsed playing time      Current track

All tracks will be played repeatedly until you stop playback.

### Note:

When a CD is inserted upside down, "EJECT" and the CD-in indicator flash on the display and the CD automatically ejects.

### To stop play and eject the CD

Press ▲.

CD play stops and the CD automatically ejects from the loading slot. The source changes to the tuner (you will hear the last received station.)

- If you change the source, CD play also stops (without ejecting the CD).

Next time you select "CD" as the source, CD play starts from where playback has been stopped previously.

### Notes:

- If the ejected disc is not removed for about 15 seconds, the disc is automatically inserted again into the loading slot to protect it from dust. (CD play will not start this time.)
- You can eject the CD even when the unit is turned off.

### About mistracking:

Mistracking may result from driving on extremely rough roads. This does not damage the unit and the CD, but will be annoying.

We recommend that you stop CD play while driving on such rough roads.





## Selecting CD playback modes

### To play back tracks at random (Disc Random Play)

You can play back all tracks on the CD at random.



- 1 Press M (MODE) to enter the functions mode while playing a CD.

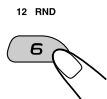

- 2 Press RND (random), while still in the functions mode, so that "DISC RND" appears on the display. Each time you press the button, disc random play mode turns on and off alternately.

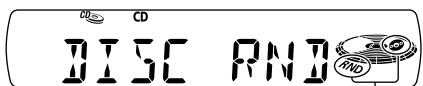

RND (disc random) indicator

When disc random play is turned on, the RND indicator lights up on the display. A track randomly selected starts playing.

### To play back tracks repeatedly (Track Repeat Play)

You can play back the current track repeatedly.



- 1 Press M (MODE) to enter the functions mode while playing a CD.

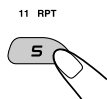

- 2 Press RPT (repeat), while still in the functions mode, so that "TRK RPT" appears on the display. Each time you press the button, track repeat play mode turns on and off alternately.

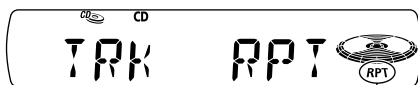

RPT indicator

When track repeat play is turned on, the RPT indicator lights up on the display. The current track starts playing repeatedly.

## Prohibiting CD ejection

You can prohibit CD ejection and can lock a CD in the loading slot.

**While pressing CD, press and hold ▲ for more than 2 seconds.**

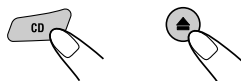

"EJECT" flashes on the display for about 5 seconds, and the CD is locked and cannot be ejected.



**To cancel the prohibition and unlock the CD,** press ▲ again for more than 2 seconds, while pressing CD.

"EJECT" and the CD-in indicator flash on the display, and the CD ejects from the loading slot.

The CD-in indicator flashes.





## Selecting preset sound modes (C-EQ: custom equalizer)

You can select a preset sound mode (C-EQ: custom equalizer) suitable to the music genre.

### Select the sound mode you want.

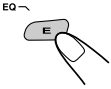

When you press the button once, the last selected sound mode is recalled and applied to the current source.



Ex.: If you have selected "USER" previously

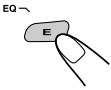

Then, each time you press the button, the sound modes change as follows:



The EQ indicator lights up when any sound mode other than "USER" is selected.

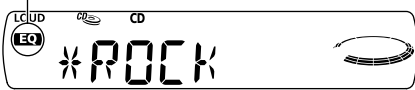

Ex.: When you select "ROCK"

Indication	For:	Preset values		
		BAS	TRE	LOUD
USER	(Flat sound)	00	00	OFF
ROCK	Rock or disco music	+03	+01	ON
CLASSIC	Classical music	+01	-02	OFF
POPS	Light music	+04	+01	OFF
HIP HOP	Funk or rap music	+02	00	ON
JAZZ	Jazz music	+02	+03	OFF

### Note:

You can adjust each sound mode to your preference. Once you make an adjustment, it is automatically stored for the currently selected sound mode. See "Adjusting the sound" on page 16.



## Adjusting the sound

You can adjust the sound characteristics to your preference.

### 1 Select the item you want to adjust.



Each time you press the button, the adjustable items change as follows:

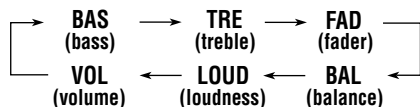

Indication	To do:	Range
BAS* <sup>1</sup>	Adjust the bass.	-06 (min.)   +06 (max.)
TRE* <sup>1</sup>	Adjust the treble.	-06 (min.)   +06 (max.)
FAD* <sup>2</sup>	Adjust the front and rear speaker balance.	R06 (Rear only)   F06 (Front only)
BAL	Adjust the left and right speaker balance.	L06 (Left only)   R06 (Right only)
LOUD* <sup>1</sup>	Boost low and high frequencies to produce a well-balanced sound at low volume level.	LOUD ON   LOUD OFF
VOL* <sup>3</sup>	Adjust the volume.	00 (min.)   50 (max.)

\*<sup>1</sup> When you adjust the bass, treble, or loudness, the adjustment you have made is stored for the currently selected sound mode (C-EQ) including "USER."

\*<sup>2</sup> If you are using a two-speaker system, set the fader level to "00."

\*<sup>3</sup> Normally the control dial works as the volume control. So you do not have to select "VOL" to adjust the volume level.

### 2 Adjust the setting.

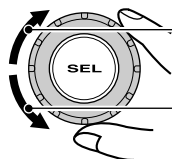

To increase the level or turn on the loudness

To decrease the level or turn off the loudness

Equalization pattern changes as you adjust the bass or treble.

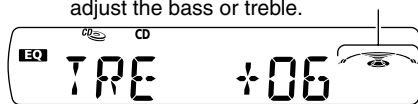

Ex. 1: When you adjust "TRE" (treble)

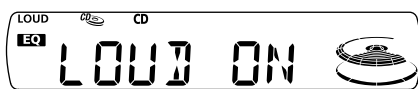

Ex. 2: When you turn on the loudness

### 3 Repeat steps 1 and 2 to adjust the other items.

To reset each sound mode to the factory settings, repeat the same procedure and reassign the preset values listed in the table on page 15.



# OTHER MAIN FUNCTIONS



## Selecting the level display

You can select the level display according to your preference.  
When shipped from the factory, "AUDIO 2" is selected.

- 1 Press and hold SEL (select) for more than 2 seconds.**  
"CLOCK H," "CLOCK M," or "LEVEL" appears on the display.



- 2 Select "LEVEL" if not shown on the display.**

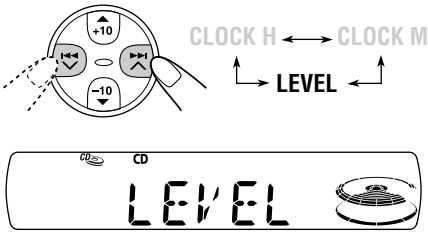

- 3 Select the desired mode.**

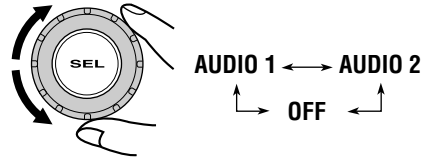

Ex.: When you select "AUDIO 2"

- AUDIO 1: Shows the audio level indicator.
- AUDIO 2: Alternates "AUDIO 1" setting and illumination display.
- OFF: Erases the audio level indicator.

- 4 Finish the setting.**





## Detaching the control panel

You can detach the control panel when leaving the car.  
When detaching or attaching the control panel, be careful not to damage the connectors on the back of the control panel and on the panel holder.

### Detaching the control panel

Before detaching the control panel, be sure to turn off the power.

- 1** Unlock the control panel.

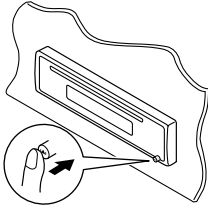

- 2** Lift and pull the control panel out of the unit.

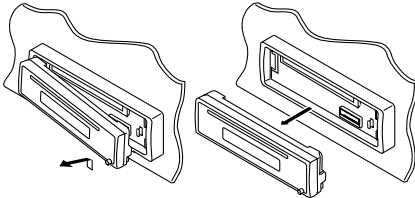

- 3** Put the detached control panel into the provided case.

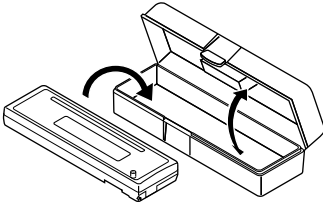

## Attaching the control panel

- 1** Insert the left side of the control panel into the groove on the panel holder.

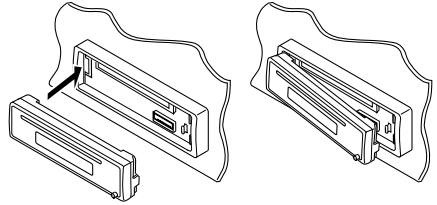

- 2** Press the right side of the control panel to fix it to the panel holder.

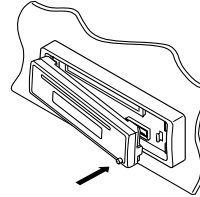

### Note on cleaning the connectors:

*If you frequently detach the control panel, the connectors will deteriorate.*

*To minimize this possibility, periodically wipe the connectors with a cotton swab or cloth moistened with alcohol, being careful not to damage the connectors.*

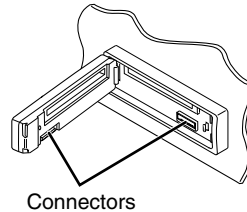

# TROUBLESHOOTING



What appears to be trouble is not always serious. Check the following points before calling a service center.

	Symptoms	Causes	Remedies
General	<ul style="list-style-type: none"> <li>Sound cannot be heard from the speakers.</li> </ul>	The volume level is set to the minimum level.  Connections are incorrect.	Adjust it to the optimum level.  Check the cords and connections.
	<ul style="list-style-type: none"> <li>This unit does not work at all.</li> </ul>	The built-in microcomputer may have functioned incorrectly due to noise, etc.	While holding SEL (select), press <b>⏻/I/ATT</b> (standby/on/attenuator) for more than 2 seconds to reset the unit. (The clock setting and preset stations stored in memory are erased.) (See page 2.)
FM/AM	<ul style="list-style-type: none"> <li>SSM (Strong-station Sequential Memory) automatic preset does not work.</li> </ul>	Signals are too weak.	Store stations manually.
	<ul style="list-style-type: none"> <li>Static noise while listening to the radio.</li> </ul>	The antenna is not connected firmly.	Connect the antenna firmly.
CD Playback	<ul style="list-style-type: none"> <li>CD automatically ejects.</li> </ul>	CD is inserted upside down.	Insert the CD correctly.
	<ul style="list-style-type: none"> <li>CD-R/CD-RW cannot be played back.</li> <li>Tracks on the CD-R/CD-RW cannot be skipped.</li> </ul>	CD-R/CD-RW is not finalized.	<ul style="list-style-type: none"> <li>Insert a finalized CD-R/CD-RW.</li> <li>Finalize the CD-R/CD-RW with the component which you used for recording.</li> </ul>
	<ul style="list-style-type: none"> <li>CD can be neither played back nor ejected.</li> </ul>	CD is locked.	Unlock the CD. (See page 14.)
		The CD player may function incorrectly.	While holding <b>⏻/I/ATT</b> (standby/on/attenuator), press <b>▲</b> (eject) for more than 2 seconds. Be careful not to drop the CD when it is ejected.
	<ul style="list-style-type: none"> <li>CD sound is sometimes interrupted.</li> </ul>	You are driving on rough roads.	Stop playback while driving on rough roads.
		CD is scratched.	Change the CD.
		Connections are incorrect.	Check the cords and connections.
	<ul style="list-style-type: none"> <li>"NO DISC" appears on the display.</li> </ul>	No CD in the loading slot.	Insert a CD into the loading slot.
CD is inserted incorrectly.		Insert the CD correctly.	



# MAINTENANCE

## Handling discs

This unit has been designed to reproduce CDs, CD-Rs (Recordable), and CD-RWs (Rewritable).  
• **This unit is not compatible with MP3 discs.**

### How to handle discs

**When removing a disc from its case**, press down the center holder of the case and lift the disc out, holding it by the edges.

Center holder



- Always hold the disc by the edges. Do not touch its recording surface.

**When storing a disc into its case**, gently insert the disc around the center holder (with the printed surface facing up).

- Make sure to store discs into the cases after use.

### To keep discs clean

A dirty disc may not play correctly. If a disc does become dirty, wipe it with a soft cloth in a straight line from center to edge.



### To play new discs

New discs may have some rough spots around the inner and outer edges. If such a disc is used, this unit may reject the disc.



To remove these rough spots, rub the edges with a pencil or ball-point pen, etc.

### Moisture condensation

Moisture may condense on the lens inside the CD player in the following cases:

- After starting the heater in the car.
- If it becomes very humid inside the car.

Should this occur, the CD player may malfunction. In this case, eject the disc and leave the unit turned on for a few hours until the moisture evaporates.

## When playing a CD-R or CD-RW

Before playing back CD-Rs or CD-RWs, read their instructions or cautions carefully.

- Use only “finalized” CD-Rs or CD-RWs.
- Some CD-Rs or CD-RWs may not play back on this unit because of their disc characteristics, and for the following reasons:
  - Discs are dirty or scratched.
  - Moisture condensation on the lens inside the unit.
  - The pickup lens inside the unit is dirty.
- CD-RWs may require a longer readout time since the reflectance of CD-RWs is lower than that of regular CDs.
- CD-Rs or CD-RWs are susceptible to high temperatures or high humidity, so do not leave them inside your car.
- Do not use following CD-Rs or CD-RWs:
  - Discs with stickers, labels, or protective seal stuck to the surface.
  - Discs on which labels can be directly printed by an ink jet printer.

Using these discs under high temperatures or high humidity may cause malfunctions or damage to discs. For example,

- Stickers or labels may shrink and warp a disc.
  - Stickers or labels may peel off so discs cannot be ejected.
  - Print on discs may get sticky.
- Read instructions or cautions about labels and printable discs carefully.

### CAUTIONS:

- Do not insert 8 cm (3 3/16") discs (single CDs) into the loading slot. (Such discs cannot be ejected.)
- Do not insert any disc of unusual shape—like a heart or flower; otherwise, it will cause a malfunction.
- Do not expose discs to direct sunlight or any heat source or place them in a place subject to high temperature and humidity. Do not leave them in a car.
- Do not use any solvent (for example, conventional record cleaner, spray, thinner, benzine, etc.) to clean discs.

Warped disc



Sticker



Sticker residue

Disc



Stick-on label

# SPECIFICATIONS

## AUDIO AMPLIFIER SECTION

Maximum Power Output:

Front: 45 W per channel

Rear: 45 W per channel

Continuous Power Output (RMS):

Front: 17 W per channel into 4  $\Omega$ , 40 Hz to 20 000 Hz at no more than 0.8% total harmonic distortion.

Rear: 17 W per channel into 4  $\Omega$ , 40 Hz to 20 000 Hz at no more than 0.8% total harmonic distortion.

Load Impedance: 4  $\Omega$  (4  $\Omega$  to 8  $\Omega$  allowance)

Tone Control Range:

Bass:  $\pm 10$  dB at 100 Hz

Treble:  $\pm 10$  dB at 10 kHz

Frequency Response: 40 Hz to 20 000 Hz

Signal-to-Noise Ratio: 70 dB

Line-Out Level/Impedance:

2.0 V/20 k $\Omega$  load (full scale)

Output Impedance: 1 k $\Omega$

## TUNER SECTION

Frequency Range:

FM: 87.5 MHz to 107.9 MHz

AM: 530 kHz to 1 710 kHz

### **[FM Tuner]**

Usable Sensitivity:

11.3 dBf (1.0  $\mu$ V/75  $\Omega$ )

50 dB Quietening Sensitivity:

16.3 dBf (1.8  $\mu$ V/75  $\Omega$ )

Alternate Channel Selectivity (400 kHz):

65 dB

Frequency Response: 40 Hz to 15 000 Hz

Stereo Separation: 35 dB

Capture Ratio: 1.5 dB

### **[AM Tuner]**

Sensitivity: 20  $\mu$ V

Selectivity: 35 dB

## CD PLAYER SECTION

Type: Compact disc player

Signal Detection System: Non-contact optical pickup (semiconductor laser)

Number of channels: 2 channels (stereo)

Frequency Response: 5 Hz to 20 000 Hz

Dynamic Range: 96 dB

Signal-to-Noise Ratio: 98 dB

Wow and Flutter: Less than measurable limit

## GENERAL

Power Requirement:

Operating Voltage: DC 14.4 V

(11 V to 16 V allowance)

Grounding System: Negative ground

Allowable Operating Temperature:

0°C to +40°C (32°F to 104°F)

Dimensions (W  $\times$  H  $\times$  D):

Installation Size (approx.):

182 mm  $\times$  52 mm  $\times$  150 mm

(7-3/16"  $\times$  2-1/16"  $\times$  5-15/16")

Panel Size (approx.):

188 mm  $\times$  58 mm  $\times$  11 mm

(7-7/16"  $\times$  2-5/16"  $\times$  7/16")

Mass (approx.):

1.3 kg (2.9 lbs) (excluding accessories)

*Design and specifications are subject to change without notice.*

If a kit is necessary for your car, consult your telephone directory for the nearest car audio speciality shop.



**JVC**

**MOBILE  
ENTERTAINMENT**

**<http://www.jvcmobile.com>**

*Visit us on-line for*

*Technical Support & Customer Satisfaction Survey.*

**US RESIDENTS ONLY**

**Having TROUBLE with operation?  
Please reset your unit**

**Refer to page of How to Reset  
Still having trouble??**

**USA ONLY**

**Call 1-800-252-5722**

**<http://www.jvc.com>**

**We can help you!**

**JVC**

VICTOR COMPANY OF JAPAN, LIMITED



EN, SP, FR

© 2002 VICTOR COMPANY OF JAPAN, LIMITED



1202KKSMdTJEIN

# JVC KD-S890/KD-S7350/KD-S690

## Installation/Connection Manual Manual de instalación/conexión Manuel d'installation/raccordement

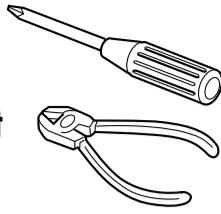

GET0131-002A  
[J]

1202KKSMDTJEIN  
EN, SP, FR

### ENGLISH

- This unit is designed to operate on 12 V DC, NEGATIVE ground electrical systems.

## INSTALLATION (IN-DASH MOUNTING)

- The following illustration shows a typical installation. However, you should make adjustments corresponding to your specific car. If you have any questions or require information regarding installation kits, consult your JVC car audio dealer or a company supplying kits.

### ESPAÑOL

- Esta unidad está diseñada para funcionar con 12 V de CC, con sistemas eléctricos de masa NEGATIVA.

## INSTALACION (MONTAJE EN EL TABLERO DE INSTRUMENTOS)

- La siguiente ilustración muestra una instalación típica. Sin embargo usted deberá efectuar los ajustes correspondientes a su automóvil. Si tiene alguna pregunta o necesita información acerca de las herramientas para instalación, consulte con su concesionario de JVC de equipos de audio para automóviles o a una compañía que suministra tales herramientas.

### FRANÇAIS

- Cet appareil est conçu pour fonctionner sur des sources de courant continu de 12 V à masse NEGATIVE.

## INSTALLATION (MONTAGE DANS LE TABLEAU DE BORD)

- L'illustration suivante est un exemple d'installation typique. Cependant, vous devez faire les ajustements correspondant à votre voiture particulière. Si vous avez des questions ou avez besoin d'information sur des kits d'installation, consulter votre revendeur d'autoradios JVC ou une compagnie d'approvisionnement.

- 1 Before mounting:** Press (control panel release button) to detach the control panel if already attached.  
\* When shipped from the factory, the control panel is packed in the hard case.
- 2** Remove the trim plate.
- 3** Remove the sleeve after disengaging the sleeve locks.
  - Stand the unit.**Note:** When you stand the unit, be careful not to damage the fuse on the rear.
  - Insert the 2 handles between the unit and the sleeve, as illustrated, to disengage the sleeve locks.
  - Remove the sleeve.**Note:** Be sure to keep the handles for future use after installing the unit.
- 4** Install the sleeve into the dashboard.  
\* After the sleeve is correctly installed into the dashboard, bend the appropriate tabs to hold the sleeve firmly in place, as illustrated.
- 5** Fix the mounting bolt to the rear of the unit's body and place the rubber cushion over the end of the bolt.
- 6** Do the required electrical connections.
- 7** Slide the unit into the sleeve until it is locked.
- 8** Attach the trim plate.
- 9** Attach the control panel.

- 1 Antes de instalar:** Pulse (soltar panel de control) para separar el panel de control si ya está unido.  
\* Cuando se envía de la fábrica, el panel de control está embalado en el estuche duro.
- 2** Retire la placa de guarnición.
- 3** Retire la cubierta después de desenganchar los retenes de la cubierta.
  - Ponga la unidad vertical.**Nota:** Al poner la unidad vertical, tenga cuidado de no dañar el fusible provisto en la parte posterior.
  - Inserte las 2 manijas entre la unidad y la cubierta tal como en la ilustración y desenganche los retenes de la cubierta.
  - Retire la cubierta.**Nota:** Después de instalar la unidad, asegúrese de guardar las manijas para uso futuro.
- 4** Instale la cubierta en el tablero de instrumentos.  
\* Después de que la cubierta esté correctamente instalada en el tablero de instrumentos, doble las lengüetas correspondientes para sostener la cubierta firmemente en su lugar, tal como se muestra.
- 5** Fije el perno de montaje en la parte trasera del cuerpo de la unidad y coloque el cojín de goma sobre el extremo del perno.
- 6** Realice las conexiones eléctricas requeridas.
- 7** Deslice la unidad dentro de la cubierta hasta que quede trabada.
- 8** Coloque la placa de guarnición.
- 9** Coloque el panel de control.

- 1 Avant le montage:** Appuyer sur (déblocage du panneau de commande) pour éventuellement détacher le panneau de commande.  
\* Lorsque ce panneau de commande sort d'usine, il est rangé dans un étui de transport.
- 2** Retirer la plaque d'assemblage.
- 3** Libérer les verrous du manchon et retirer le manchon.
  - Poser l'appareil à la verticale.**Remarque:** Lorsque vous mettez l'appareil à la verticale, faire attention de ne pas endommager le fusible situé sur l'arrière.
  - Insérer les 2 poignées entre l'appareil et le manchon comme indiqué pour désengager les verrous de manchon.
  - Retirer le manchon.**Remarque:** S'assurer de garder les poignées pour une utilisation ultérieure, après l'installation de l'appareil.
- 4** Installer le manchon dans le tableau de bord.  
\* Après installation correcte du manchon dans le tableau de bord, plier les bonnes pattes pour maintenir fermement le manchon en place, comme montré.
- 5** Monter le boulon de montage sur l'arrière du corps de l'appareil puis passer l'amortisseur en caoutchouc sur l'extrémité du boulon.
- 6** Réaliser les connexions électriques.
- 7** Faire glisser l'appareil dans le manchon jusqu'à ce qu'il soit verrouillé.
- 8** Attachez la plaque d'assemblage.
- 9** Remonter le panneau de commande.

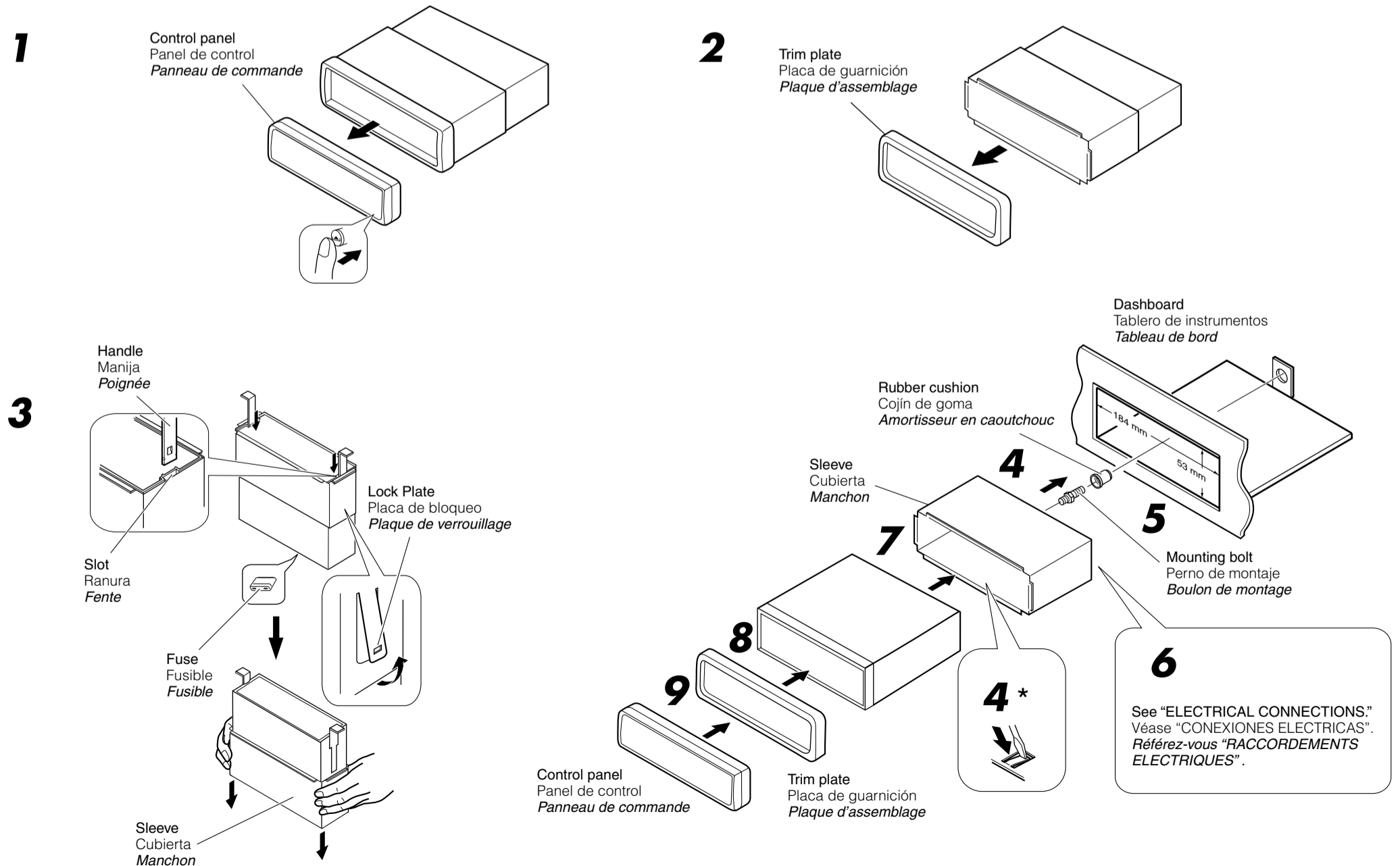

- When using the optional stay
- Cuando emplea un soporte opcional
- Lors de l'utilisation du hauban en option

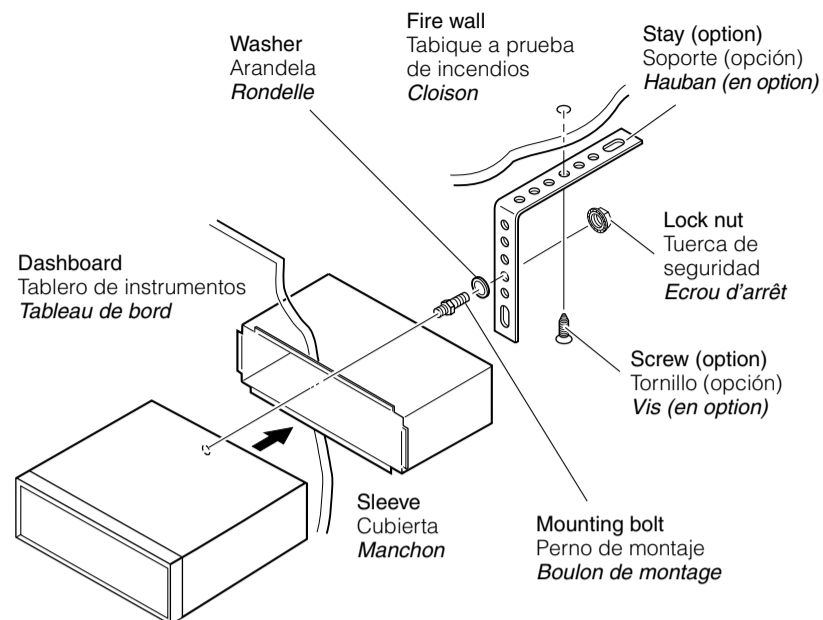

- When installing the unit without using the sleeve
- Instalación de la unidad sin utilizar la manga
- Lors de l'installation de l'appareil sans utiliser de manchon

In a Toyota for example, first remove the car radio and install the unit in its place.  
En un Toyota por ejemplo, primero retire la radio del automóvil y luego instale la unidad en su lugar.  
Par exemple dans une Toyota, retirer d'abord l'autoradio et installer l'appareil à la place.

Flat type screws (M5 x 6 mm)\*  
Tornillos tipo plano (M5 x 6 mm)\*  
Vis à tête plate (M5 x 6 mm)\*

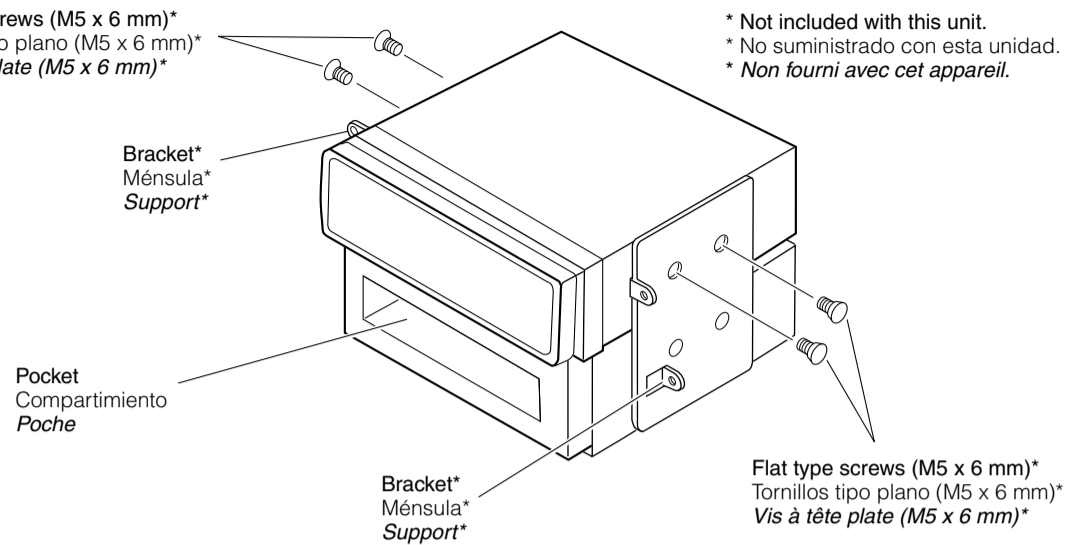

\* Not included with this unit.  
\* No suministrado con esta unidad.  
\* Non fourni avec cet appareil.

**Note** : When installing the unit on the mounting bracket, make sure to use the 6 mm-long screws. If longer screws are used, they could damage the unit.  
**Nota** : Cuando instala la unidad en la ménsula de montaje, asegúrese de utilizar los tornillos de 6 mm de longitud. Si se utilizan tornillos más largos, éstos pueden dañar la unidad.  
**Remarque** : Lors de l'installation de l'appareil sur le support de montage, s'assurer d'utiliser des vis d'une longueur de 6 mm. Si des vis plus longues sont utilisées, elles peuvent endommager l'appareil.

### Removing the unit

- Before removing the unit, release the rear section.

- 1 Remove the control panel.
- 2 Remove the trim plate.
- 3 Insert the 2 handles into the slots, as shown. Then, while gently pulling the handles away from each other, slide out the unit. (Be sure to keep the handles after installing it.)

### Extracción de la unidad

- Antes de extraer la unidad, libere la sección trasera.

- 1 Retire el panel de control.
- 2 Retire la placa de guarnición.
- 3 Inserte las 2 manijas entre las ranuras, como se muestra. Luego, separe gentilmente las manijas y extraiga la unidad. (Asegúrese de conservar las manijas después de instalarlo.)

### Retrait de l'appareil

- Avant de retirer l'appareil, libérer la section arrière.

- 1 Retirer le panneau de commande.
- 2 Retirer la plaque d'assemblage.
- 3 Introduire les 2 poignées dans les fentes, comme montré. Puis, tout en tirant doucement les poignées écartées, faire glisser l'appareil pour le sortir. (S'assurer de conserver les poignées après l'installation de l'appareil.)

1

Control panel  
Panel de control  
Panneau de commande

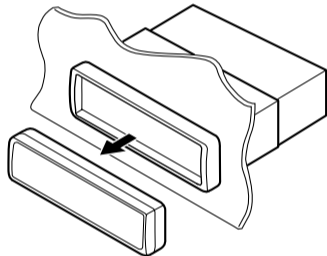

2

Trim plate  
Placa de guarnición  
Plaque d'assemblage

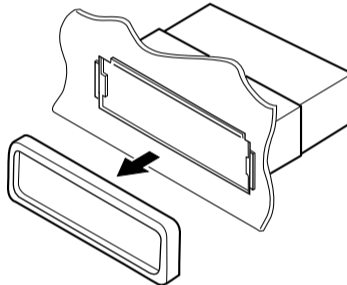

3

Handle  
Manija  
Poignée

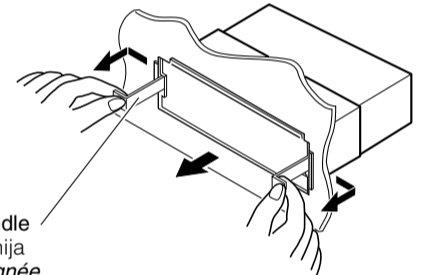

### Parts list for installation and connection

The following parts are provided with this unit.  
After checking them, please set them correctly.

Hard case/Control panel  
Estuche duro/Panel de control  
Etui de transport/Panneau de commande

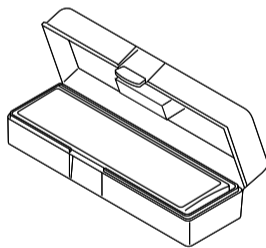

Trim plate  
Placa de guarnición  
Plaque d'assemblage

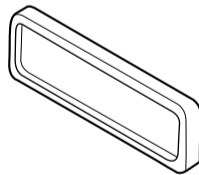

Handles  
Manijas  
Poignées

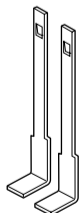

Mounting bolt (M5 x 20 mm)  
Perno de montaje (M5 x 20 mm)  
Boulon de montage (M5 x 20 mm)



Rubber cushion  
Cojín de goma  
Amortisseur en caoutchouc



### Lista de piezas para instalación y conexión

Con esta unidad se suministran las siguientes piezas.  
Después de inspeccionarlas, colóquelas correctamente.

Sleeve  
Cubierta  
Manchon

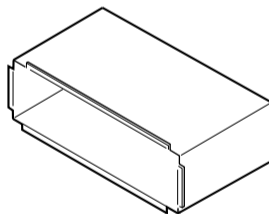

Power cord  
Cordón de alimentación  
Cordon d'alimentation

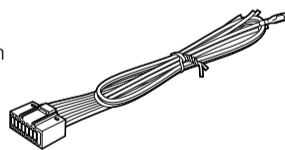

Lock nut (M5)  
Tuerca de seguridad (M5)  
Ecrou d'arrêt (M5)



Washer (ø5)  
Arandela (ø5)  
Rondelle (ø5)



### Liste des pièces pour l'installation et raccordement

Les pièces suivantes sont fournies avec cet appareil.  
Après vérification, veuillez les placer correctement.

#### RM-RK50

For KD-S890  
Para KD-S890  
Pour le KD-S890

Remote controller  
Mando a distancia  
Télécommande

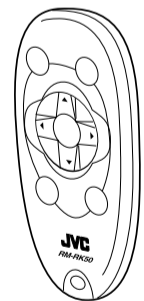

Battery  
Pila  
Pile



#### RM-RK60

For KD-S7350/KD-S690  
Para KD-S7350/KD-S690  
Pour le KD-S7350/KD-S690

Remote controller  
Mando a distancia  
Télécommande

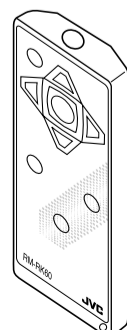

Battery  
Pila  
Pile





# ELECTRICAL CONNECTIONS

To prevent short circuits, we recommend that you disconnect the battery's negative terminal and make all electrical connections before installing the unit. If you are not sure how to install this unit correctly, have it installed by a qualified technician.

**Note:**

This unit is designed to operate on **12 V DC, NEGATIVE ground electrical systems**. If your vehicle does not have this system, a voltage inverter is required, which can be purchased at JVC car audio dealers.

- Replace the fuse with one of the specified rating. If the fuse blows frequently, consult your JVC car audio dealer.
- If noise is a problem...  
This unit incorporates a noise filter in the power circuit. However, with some vehicles, clicking or other unwanted noise may occur. If this happens, connect the unit's **rear ground terminal** (see connection diagram) to the car's chassis using shorter and thicker cords, such as copper braiding or gauge wire. If noise still persists, consult your JVC car audio dealer.
- Maximum input of the speakers should be more than 50 W (for KD-S890) and 45 W (for KD-S7350/KD-S690) both at the rear and at the front, with an impedance of **4 Ω to 8 Ω**.
- **Be sure to ground this unit to the car's chassis.**
- The heat sink becomes very hot after use. Be careful not to touch it when removing this unit.

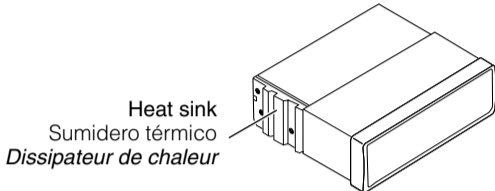

# CONEXIONES ELECTRICAS

Para evitar cortocircuitos, recomendamos que desconecte el terminal negativo de la batería y que efectúe todas las conexiones eléctricas antes de instalar la unidad. Si usted no está seguro de cómo instalar correctamente la unidad, hágala instalar por un técnico cualificado.

**Nota:**

Esta unidad está diseñada para funcionar con **12 V de CC, con sistemas eléctricos de masa NEGATIVA**. Si su vehículo no posee este sistema, será necesario un inversor de tensión, que puede ser adquirido en los concesionarios de JVC de equipos de audio para automóviles.

- Reemplace el fusible por uno con la corriente especificada. Si el fusible se quemase frecuentemente consulte con su concesionario de JVC de equipos de audio para automóviles.
- Si el ruido fuese un problema...  
Esta unidad tiene un filtro de ruido en el circuito de alimentación. Sin embargo, en algunos vehículos, pueden producirse chasquidos u otros ruidos indeseados. En tal caso conecte el **terminal de tierra posterior** (véase diagrama de conexión) del receptor al chasis del automóvil, utilizando cordones más gruesos y cortos tales como alambre de cobre trenzado o de grueso calibre. Si el ruido persiste, consulte a su concesionario de JVC de equipos de audio para automóvil.
- La entrada máxima de los altavoces debe ser de más de 50 W (para KD-S890) y de 45 W (para KD-S7350/KD-S690) tanto en la parte trasera como en la delantera, con una impedancia de **4 Ω a 8 Ω**.
- **Asegúrese de conectar esta unidad a tierra en el chasis del automóvil.**
- El sumidero térmico estará muy caliente después del uso. Asegúrese de no tocarlo al desmontar esta unidad.

# RACCORDEMENTS ELECTRIQUES

Pour éviter tout court-circuit, nous vous recommandons de débrancher la borne négative de la batterie et d'effectuer tous les raccordements électriques avant d'installer l'appareil. Si l'on n'est pas sûr de pouvoir installer correctement cet appareil, le faire installer par un technicien qualifié.

**Remarque:**

Cet appareil est conçu pour fonctionner sur des sources de courant continu de **12 V à masse NEGATIVE**. Si votre véhicule n'offre pas ce type d'alimentation, il vous faut un convertisseur de tension, que vous pouvez acheter chez un revendeur d'autoradios JVC.

- Remplacer le fusible par un de la valeur précisée. Si le fusible saute souvent, consulter votre revendeur d'autoradios JVC.
- Si le bruit est un problème...  
Cet appareil incorpore un filtre de bruit dans le circuit d'alimentation. Cependant, avec certains véhicules, quelques claquements ou autres bruits non désirés risquent de se produire. Si cela arrive, raccorder la **borne arrière de masse** de l'appareil au châssis de la voiture (voir le diagramme de raccordement) en utilisant des cordons les plus gros et les plus courts possibles telle qu'une barre de cuivre ou une tresse. Si le bruit persiste, consulter votre revendeur d'autoradios JVC.
- L'entrée maximum des enceintes doit être supérieure à 50 W (pour le KD-S890) et 45 W (pour le KD-S7350/KD-S690), pour l'arrière et pour l'avant, et l'impédance doit être comprise entre **4 Ω à 8 Ω**.
- **S'assurer de raccorder la mise à la masse de cet appareil au châssis de la voiture.**
- Le dissipateur de chaleur devient très chaud après usage. Faire attention de ne pas le toucher en retirant cet appareil.

## Typical connections / Conexiones típicas / Raccordements typiques

**Before connecting:** Check the wiring in the vehicle carefully. Incorrect connection may cause serious damage to this unit. The leads of the power cord and those of the connector from the car body may be different in color.

- 1 Connect the colored leads of the power cord to the car battery, speakers and automatic antenna (if any) in the following sequence.
  - ① Black: ground
  - ② Yellow: to car battery (constant 12 V)
  - ③ Red: to an accessory terminal
  - ④ Blue with white stripe: to remote lead of other equipment or automatic antenna if any (200 mA max.)
  - ⑤ Others: to speakers
- 2 Connect the antenna cord.
- 3 Finally connect the wiring harness to the unit.

**Antes de la conexión:** Verifique atentamente el conexionado del vehículo. Una conexión incorrecta podría producir daños graves en la unidad. Los cordones del cable de alimentación y los del conector procedentes de la carrocería del automóvil podrían ser de diferentes en color.

- 1 Conecte los conductores de color del cable de alimentación a la batería del automóvil, altavoces y antena motriz (si la hubiere) en la secuencia siguiente.
  - ① Negro: a tierra
  - ② Amarillo: a la batería del automóvil (12 V constantes)
  - ③ Rojo: a un terminal de accesorio
  - ④ Azul con rayas blancas: al conductor remoto de otro equipo o de la antena automática, si hubiere (máx. 200 mA)
  - ⑤ Otros: a los altavoces
- 2 Conecte el cable de antena.
- 3 Por último, conecte el cable de alimentación a la unidad.

**Avant de commencer la connexion:** Vérifiez attentivement le câblage du véhicule. Une connexion incorrecte peut endommager sérieusement l'appareil. Le fil du cordon d'alimentation et ceux des connecteurs du châssis de la voiture peuvent être différents en couleur.

- 1 Connectez les fils de couleur du cordon d'alimentation à la batterie de la voiture, aux enceintes et à l'antenne automatique (s'il y en a une) dans l'ordre suivant.
  - ① Noir: à la masse
  - ② Jaune: à la batterie de la voiture (12 V constant)
  - ③ Rouge: à une borne accessoire
  - ④ Bleu avec bande blanche: au fil de télécommande de l'autre appareil ou à l'antenne automatique s'il y en a une (200 mA max.)
  - ⑤ Autres: aux enceintes
- 2 Connectez le cordon d'antenne.
- 3 Finalement, connectez le faisceau de fils à l'appareil.

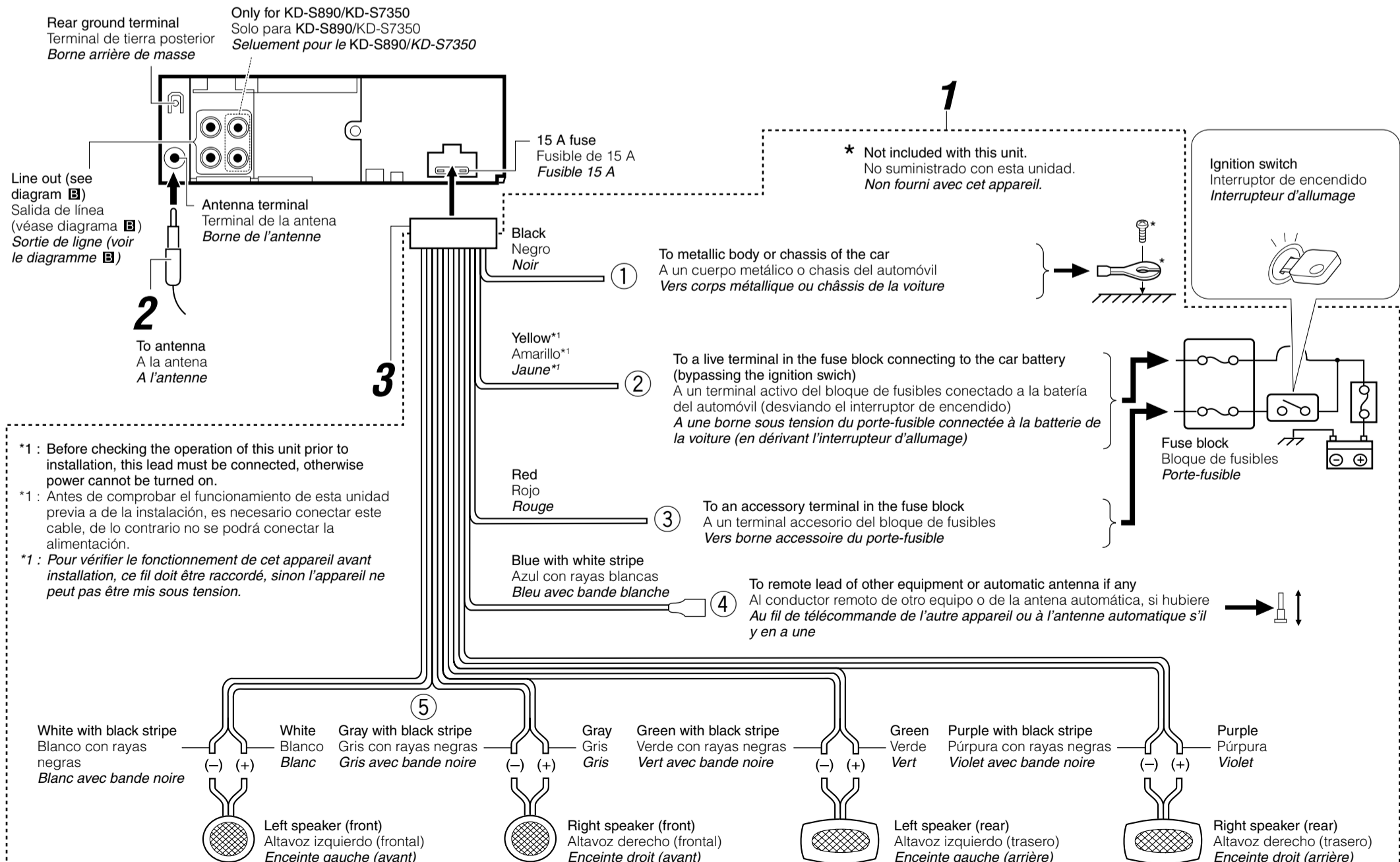

## PRECAUTIONS on power supply and speaker connections:

- **DO NOT connect the speaker leads of the power cord to the car battery; otherwise, the unit will be seriously damaged.**
- Connect the black lead (ground), yellow lead (to car battery, constant 12 V), and red lead (to an accessory terminal) correctly.
- **BEFORE connecting the speaker leads of the power cord to the speakers, check the speaker wiring in your car.**
  - **If the speaker wiring in your car is as illustrated in Fig. 1 and Fig. 2 below, DO NOT connect the unit using that original speaker wiring.** If you do, the unit will be seriously damaged.
  - Redo the speaker wiring so that you can connect the unit to the speakers as illustrated in Fig. 3.
  - **If the speaker wiring in your car is as illustrated in Fig. 3, you can connect the unit using the original speaker wiring in your car.**
  - If you are not sure of the speaker wiring of your car, consult your car dealer.

## PRECAUCIONES sobre las conexiones de la fuente de alimentación y de los altavoces:

- **NO conecte los conductores de altavoz del cable de alimentación a la batería de automóvil, pues podrían producirse graves daños en la unidad.**
- Conecte correctamente el conductor negro (a tierra), el conductor amarillo (a la batería del automóvil, 12 V constantes), y el conductor rojo (a un terminal de accesorio).
- ANTES de conectar a los altavoces los conductores de altavoz del cable de alimentación, verifique el conexionado de altavoz de su automóvil.
  - **Si el conexionado de altavoz de su automóvil es como se indica en las Fig. 1 y Fig. 2 de abajo, NO conecte la unidad utilizando ese conexionado de altavoz original.** Si lo hace, se producirán daños graves en la unidad.
  - Vuelva a efectuar el conexionado de altavoz de manera que pueda conectar la unidad a los altavoces de la manera indicada en la Fig. 3.
  - **Si el conexionado de altavoz de su automóvil es como se indica en la Fig. 3, podrá conectar la unidad utilizando el conexionado de altavoz original de su automóvil.**
  - Si tiene dudas sobre el conexionado de altavoz de su automóvil, consulte con su concesionario.

## PRECAUTIONS sur l'alimentation et la connexion des enceintes:

- **NE CONNECTEZ PAS les fils d'enceintes du cordon d'alimentation à la batterie; sinon, l'appareil serait sérieusement endommagé.**
- *Connectez correctement le fil noir (à la masse), le fil jaune (à la batterie de la voiture, 12 V constant) et le fil rouge (à la prise accessoire).*
- **AVANT de connecter les fils d'enceintes du cordon d'alimentation aux enceintes, vérifiez le câblage des enceintes de votre voiture.**
  - **Si le câblage des enceintes de votre voiture est comme montré sur la Fig. 1 ou Fig. 2 ci-dessous, NE CONNECTEZ PAS l'appareil en utilisant ce câblage original des enceintes.** Si vous le faites, l'appareil sera sérieusement endommagé.
  - Recommencez le câblage des enceintes de façon que vous puissiez connecter l'appareil aux enceintes comme montré sur la Fig. 3.
  - **Si le câblage des enceintes de votre voiture est comme montré sur la Fig. 3, vous pouvez connecter l'appareil en utilisant ce câblage original d'enceintes pour votre voiture.**
  - Si vous n'êtes pas sûrs du câblage d'enceintes de votre voiture, consulter le concessionnaire de votre voiture.

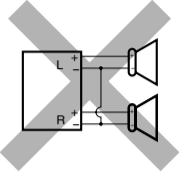

Fig. 1

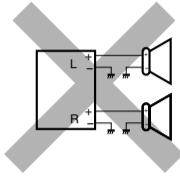

Fig. 2

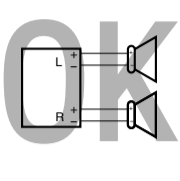
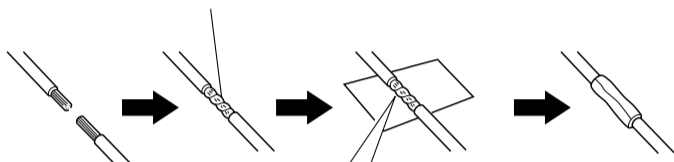

Fig. 3

## Connecting the leads / Conexión de los conductores / Raccordement des fils

Twist the core wires when connecting.  
Retuerce los alambres de alma para conectarlos.  
*Torsader les âmes des fils en les raccordant.*



Solder the core wires to connect them securely.  
Suelde los alambres de alma para conectarlos con firmeza.  
*Souder les âmes des fils pour les raccorder entre eux de façon sûre.*

### CAUTION / PRECAUCION / PRECAUTION:

- To prevent short-circuit, cover the terminals of the UNUSED leads with insulating tape.
- Para evitar cortocircuitos, cubra los cables NO UTILIZADOS con cinta aislante.
- *Pour éviter les court-circuits, couvrir les bornes des fils qui ne sont PAS UTILISÉS avec de la bande isolante.*

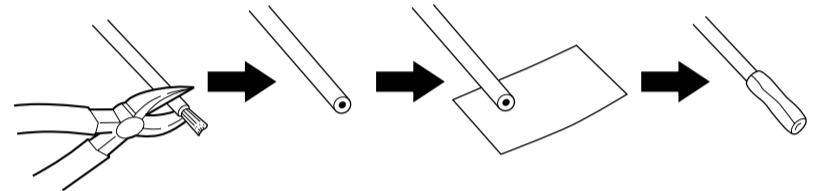

## Connections Adding Other Equipment / Conexiones para añadir otros equipos / Raccordement pour ajouter d'autres appareils

### Amplifier / Amplificador / Amplificateur

You can connect an amplifier to upgrade your car stereo system.

- Connect the remote lead (blue with white stripe) to the remote lead of the other equipment so that it can be controlled through this unit.
- Connect this unit's line-out terminals to the amplifier's line-in terminals.
- **Disconnect the speakers from this unit, connect them to the amplifier. Leave the speaker leads of this unit unused. (Cover the terminals of these unused leads with insulating tape, as illustrated above.)**

Usted podrá conectar un amplificador para mejorar el sistema estéreo de su automóvil.

- Conecte el conductor remoto (azul con rayas blancas) al conductor remoto del otro equipo para poderlo controlar a través de esta unidad.
- Conecte los terminales de salida de línea de esta unidad con los terminales de entrada de línea del amplificador.
- **Desconecte los altavoces de esta unidad y conéctelos al amplificador. Los cables de los altavoces de esta unidad quedan sin usar. (Cubra los terminales de estos cables sin usar con cinta aislante, tal comose indica en la figura de arriba.)**

Vous pouvez connecter un amplificateur pour améliorer votre système autoradio.

- Connectez le fil de commande à distance (bleu avec bande blanche) au fil de commande à distance de l'autre appareil de façon qu'il puisse être commandé via cet appareil.
- Raccordez les bornes de sortie ligne de cet appareil aux bornes d'entrée ligne de l'amplificateur.
- **Déconnectez les enceintes de cet appareil et connectez-les à l'amplificateur. Laissez les fils d'enceintes de cet appareil inutilisés. (Recouvrez les extrémités de ces fils inutilisés avec de la bande isolante comme montré ci-dessus.)**

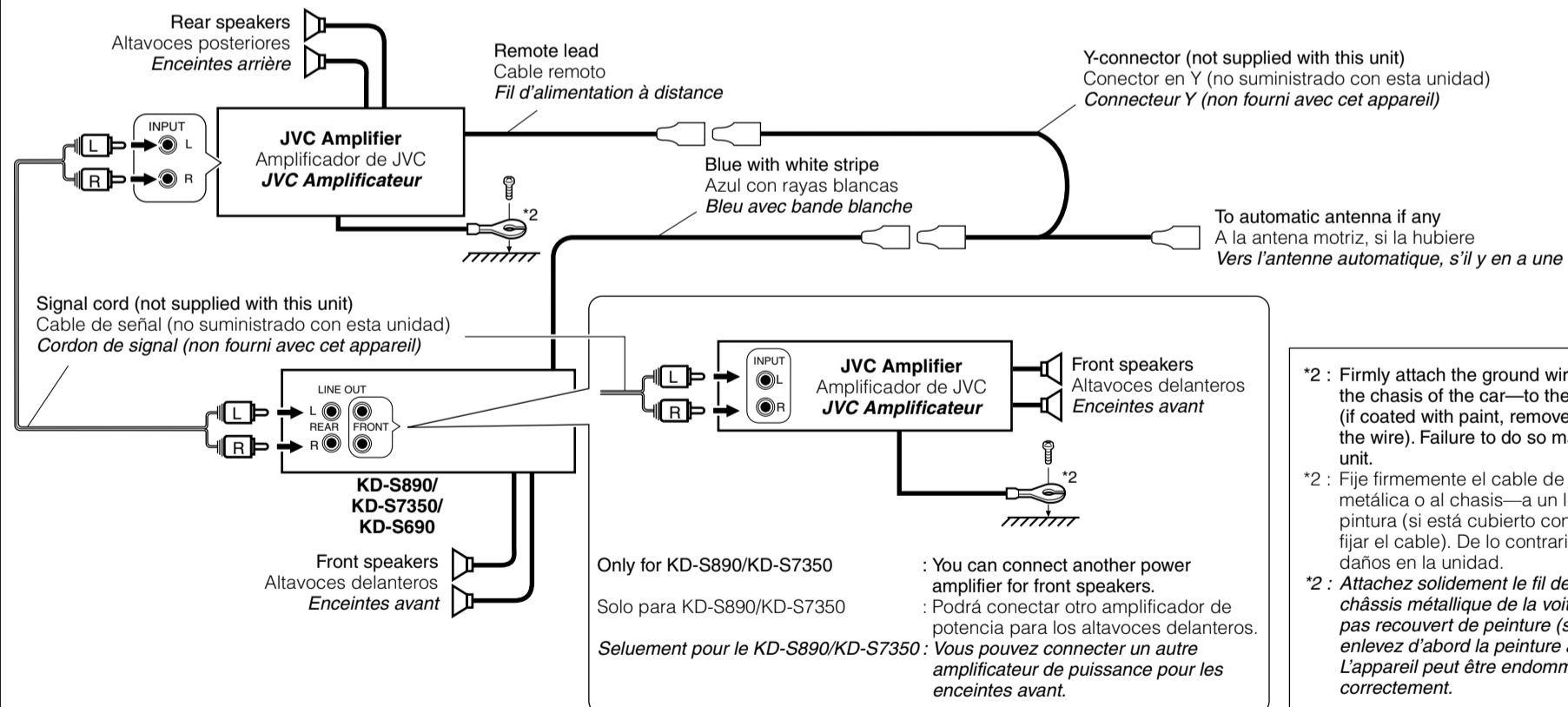

## TROUBLESHOOTING

- **The fuse blows.**
  - \* Are the red and black leads connected correctly?
- **Power cannot be turned on.**
  - \* Is the yellow lead connected?
- **No sound from the speakers.**
  - \* Is the speaker output lead short-circuited?
- **Sound is distorted.**
  - \* Is the speaker output lead grounded?
  - \* Are the “-” terminals of L and R speakers grounded in common?
- **Unit becomes hot.**
  - \* Is the speaker output lead grounded?
  - \* Are the “-” terminals of L and R speakers grounded in common?

## LOCALIZACION DE AVERIAS

- **El fusible se quema.**
  - \* ¿Están los conductores rojo y negro correctamente conectados?
- **No es posible conectar la alimentación.**
  - \* ¿Está el cable amarillo conectado?
- **No sale sonido de los altavoces.**
  - \* ¿Está el cable de salida del altavoz cortocircuitado?
- **El sonido presenta distorsión.**
  - \* ¿Está el cable de salida del altavoz conectado a masa?
  - \* ¿Están los terminales “-” de los altavoces L y R conectados a una masa común?
- **La unidad se calienta.**
  - \* ¿Está el cable de salida del altavoz conectado a masa?
  - \* ¿Están los terminales “-” de los altavoces L y R conectados a una masa común?

## EN CAS DE DIFFICULTES

- **Le fusible saute.**
  - \* *Les fils rouge et noir sont-ils raccordés correctement?*
- **L'appareil ne peut pas être mise sous tension.**
  - \* *Le fil jaune est-elle raccordée?*
- **Pas de son des enceintes.**
  - \* *Le fil de sortie d'enceinte est-il court-circuité?*
- **Le son est déformé.**
  - \* *Le fil de sortie d'enceinte est-il à la masse?*
  - \* *Les bornes “-” des enceintes gauche et droit sont-elles mises ensemble à la masse?*
- **L'appareil devient chaud.**
  - \* *Le fil de sortie d'enceinte est-il à la masse?*
  - \* *Les bornes “-” des enceintes gauche et droit sont-elles mises ensemble à la masse?*

# JVC IMPORTANT

Notice the following information will help you to solve your problems.  
Keep this IMPORTANT sheet together with the INSTRUCTIONS.

- **After installing the unit**
  - Follow the procedure **A** described below.
- **If the unit does not operate**
  - Follow the procedure **A** described below.
- **If a CD is not ejected from the loading slot**
  - Follow the procedure **B** described below. (If the procedure **B** does not work, try the procedure **A**.)
- **If a CD is not recognized (“NO DISC” appears on the display) even though there is a CD in the loading slot**
  - Follow the procedure **B** described below. (If the procedure **B** does not work, try the procedure **A**.)
- **If a CD is in the unit, it will eject when you reset the unit.**  
**Pay attention not to drop the CD.**

## **A To reset the microcomputer**

While holding SEL (select), press  $\phi$ /I/ATT (standby/on/attenuator) for more than 2 seconds. This will reset the built-in microcomputer.

**NOTE:** Your preset adjustments—such as preset channels or sound adjustments—will also be erased.

$\phi$ /I/ATT (standby/on/  
attenuator)

SEL (select)

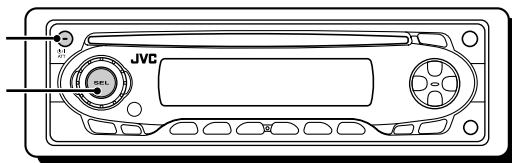

## **B To eject a CD by force**

While holding  $\phi$ /I/ATT (standby/on/attenuator), press  $\blacktriangle$  (eject) for more than 2 seconds until the CD is ejected from the loading slot. (“EJECT” and CD-in indicator flash on the display.)

$\phi$ /I/ATT (standby/on/  
attenuator)

$\blacktriangle$  (eject)

